

A (1:2)

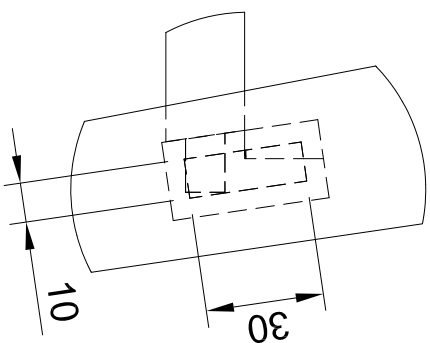

B (1:2)